

Microwave antenna

AL4-10/MP

ALCOMA

Microwave antenna description

High Performance 1.20 m antenna for point to point links.

General parameters

Diameter	1.2 m (4 ft.)
Feeder	single polarized
Input flange standard	circular, hole diameter 19.05 mm
- optional	IEC R100 (WR90)
Polarization	horizontal / vertical
Environmental temperature	-45 °C ÷ +55 °C
Color	gray
Radom material	plastic tilt
Radom color	white

Electrical parameters

Frequency band	10.300 - 10.600 GHz
Gain mid band	40.0 dBi
3dB - BW	1.6° (H/ V)
Return loss	> 1.20 (20 dB)
F/B ratio	61 dB
XPD	30 dB
Class	2 or 3 (ETSI EN 302 217)

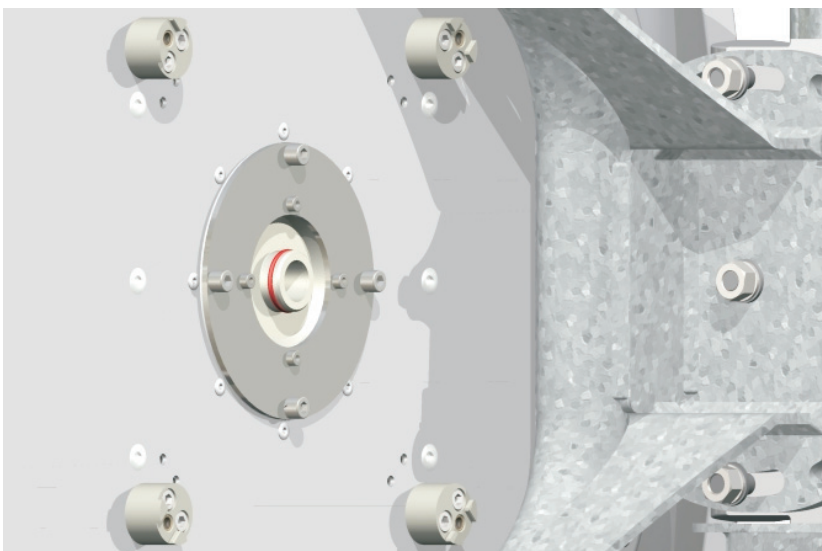

Microwave antenna AL4-10/MP

Mechanical parameters due to wind

Performance stability	up to 30 m/s (110 km/h)
Survival	up to 55 m/s (200 km/h)
Net weight	34 kg
Pipe diameter	101 - 115 mm
Fine adjust Azimuth	$\pm 7^\circ$
Fine adjust Elevation	$\pm 15^\circ$

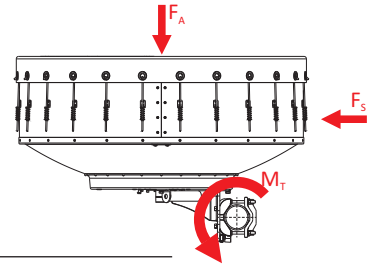

Forces and twisting moment due wind and ice

Wind velocity	30 m/s (110 km/h)	55 m/s (200 km/h)
F_a - axial force	870 N	2850 N
F_s - side force	320 N	1030 N
M_T - twisting moment	350 Nm	1150 Nm
Vertical load due to radial ice 25 mm (ice density 7kN/m ³)		670 N

Outlines

